

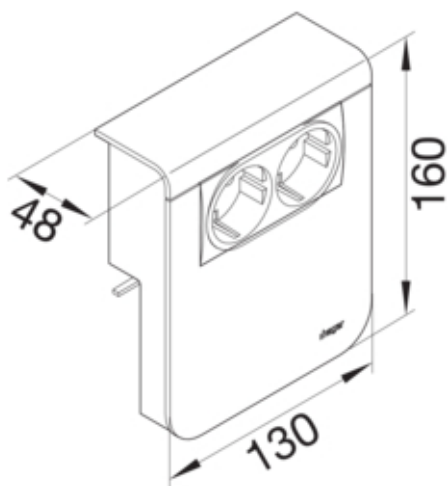

Priza SCHUKO LED SL20115, RAL9010

SL201159259010



Arhitectura

Sistem de cuplare	Altele
Tip de montaj	Blocat si înfiletat

Configuratie

Executie	Sectiune inferioara si sectiune superioara
----------	--

Compatibilitate

Format posibilitate de montare a echipamentului	deja asamblat
---	---------------

Principalele caracteristici electrice

Tensiune nominala	230 V
-------------------	-------

Curent electric

Curent nominal	16 A
----------------	------

Materiale

Culoare	alb pur
Culoare	RAL 9010 - alb pur
Material	Plastic
Material	material mixt

Dimensiuni

Adâncimea produsului instalat	48 mm
Înălțimea produsului instalat	160 mm
Înălțimea canalului	115 mm
Lungime	130 mm
Latimea canalului	20 mm
Format	Montare echipamente

Montare

Tip montaj	orizontal
------------	-----------

Accesorii incluse

preechipat cu	Priza + LED
---------------	-------------

Echipament

Numar unitati	2
---------------	---

Standarde

Autorizatii	CE
Conform directivelor europene RoHs	conformitate voluntara

Protectie

Tip de protectie IP	IP40
Fara halogen	da
Putere impact	IK07

Conditii de utilizare

Temperatura lucru	5 60 °C
-------------------	---------

Identificare

Versiune	Tari suco
----------	-----------