

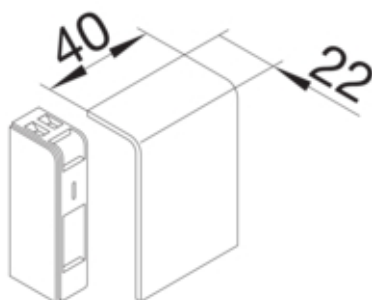

Placa de capat SL20055, RAL9010

SL2005569010



#### Arhitectura

Tip de montaj	Blocat
---------------	--------

#### Capac, usa

Sectiune superioara cu garnitura de etansare	-
--	---

#### Materiale

Culoare	alb pur
Culoare	RAL 9010 - alb pur
Material	PC - ABS fara continut de halogen
Material	Plastic
Suprafata	netratat

#### Dimensiuni

Înaltimea canalului	55 mm
Latimea canalului	20 mm

#### Standarde

Autorizatii	CE
Conform directivelor europene RoHs	conformitate voluntara

#### Protectie

Tip de protectie IP	IP40
Fara halogen	da
Putere impact	IK07

#### Conditii de utilizare

Temperatura lucru	5 60 °C
-------------------	---------